



Nominal data

Type	3312 NHH	
Nominal voltage	VDC	12
Nominal voltage range	VDC	6 .. 15
Speed (rpm)	min ⁻¹	3450
Power consumption	W	3.4
Min. ambient temperature	°C	-20
Max. ambient temperature	°C	75
Air flow	m ³ /h	107
Sound power level	B	5.4
Sound pressure level	dB(A)	42

ml = Max. load · me = Max. efficiency · fa = Free air · cs = Customer specification · ce = Customer equipment
Subject to change

Technical description

Weight	0.19 kg
Dimensions	92 x 92 x 32 mm
Impeller material	Glass-fiber reinforced PA plastic
Housing material	Glass-fiber reinforced PBT plastic
Airflow direction	Exhaust over struts
Direction of rotation	Clockwise, viewed toward rotor
Bearing	Ball bearing
Service life L10 at 40 °C	67.500 h
Service life L10 at maximum temperature	27.500 h
Cable	With leads AWG 24 UL 1061, TR 64

Product drawing

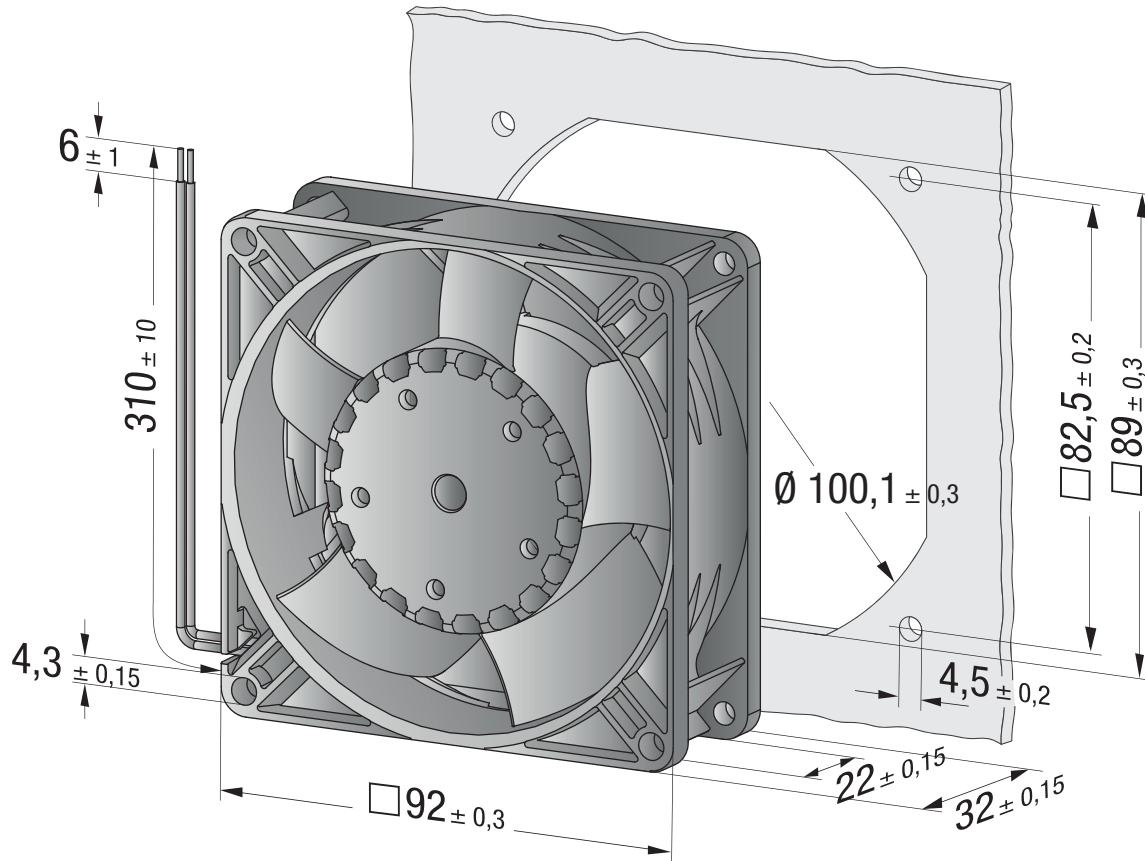

Curves

